

Installation

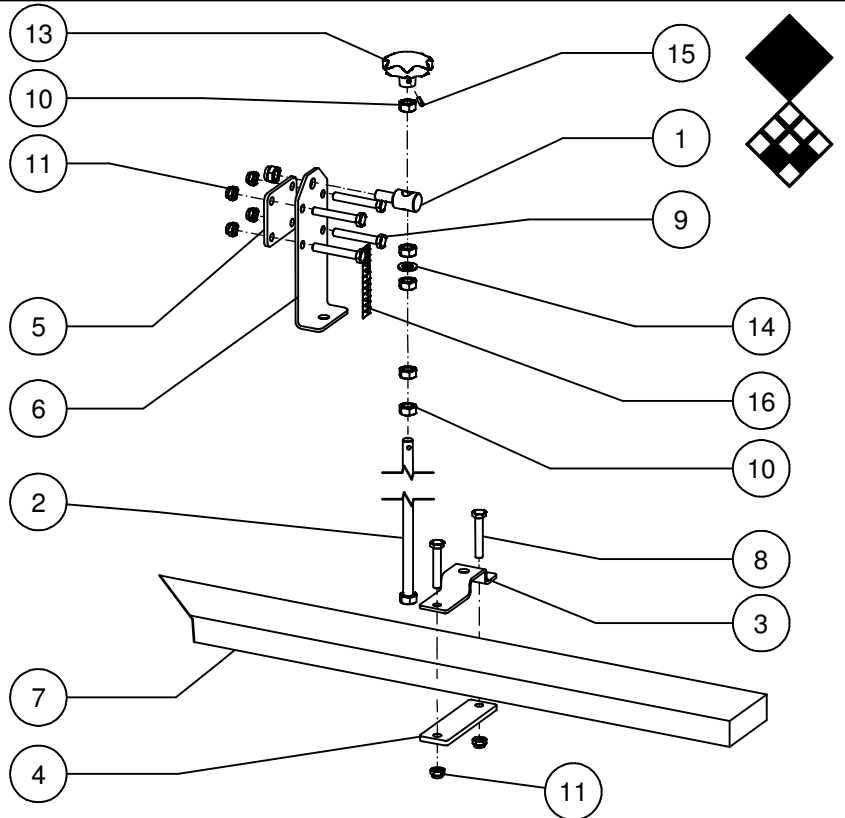

Redexim-Charterhouse Verti-Groom Magnetic Sweeper Pag 05 Code 0847

	PART #	DESCRIPTION	REMARKS	QUA
1	408.300.750	Front Roller Adjustment Bush VA2		2
2	426.164.720	Spindle		2
3	464.051.740	Clamp Bracket		2
4	464.081.740	Clamp Strip		2
5	468.061.000	Clamp Plate		2
6	468.062.500	Spindle Plate		2
7	498.213.013	Magnetic Bar Verti-Groom		1
8	802.120.700	Bolt DIN 931-1 - M12 x 70		4
9	802.120.800	Bolt DIN 931-1 - M12 x 80		8
10	826.160.160	Nut DIN 934 - M16		10
11	830.120.120	SL Nut DIN 985 - M12		12
12	830.160.160	SL Nut DIN 985 - M16		2
13	836.160.502	Knurled Knob		2
14	864.160.030	Washer DIN 125 - M16		2
15	878.060.260	Roll Pin ISO 8752 - 6 x 26 A		2
16	900.260.414	Decall ruler 120	Cut to right size	2
	261.000.002	Verti-Groom Magnetic Sweeper	Complete kit contains nr 1 till 16	1

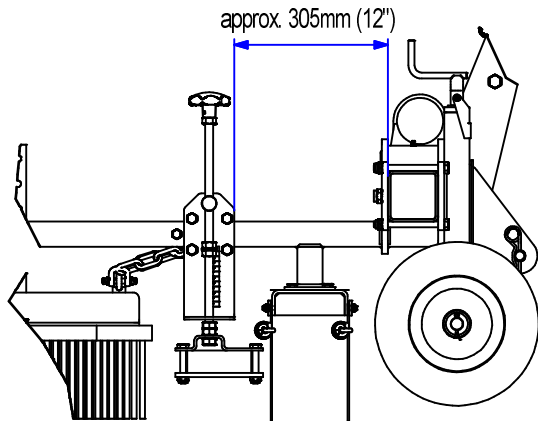
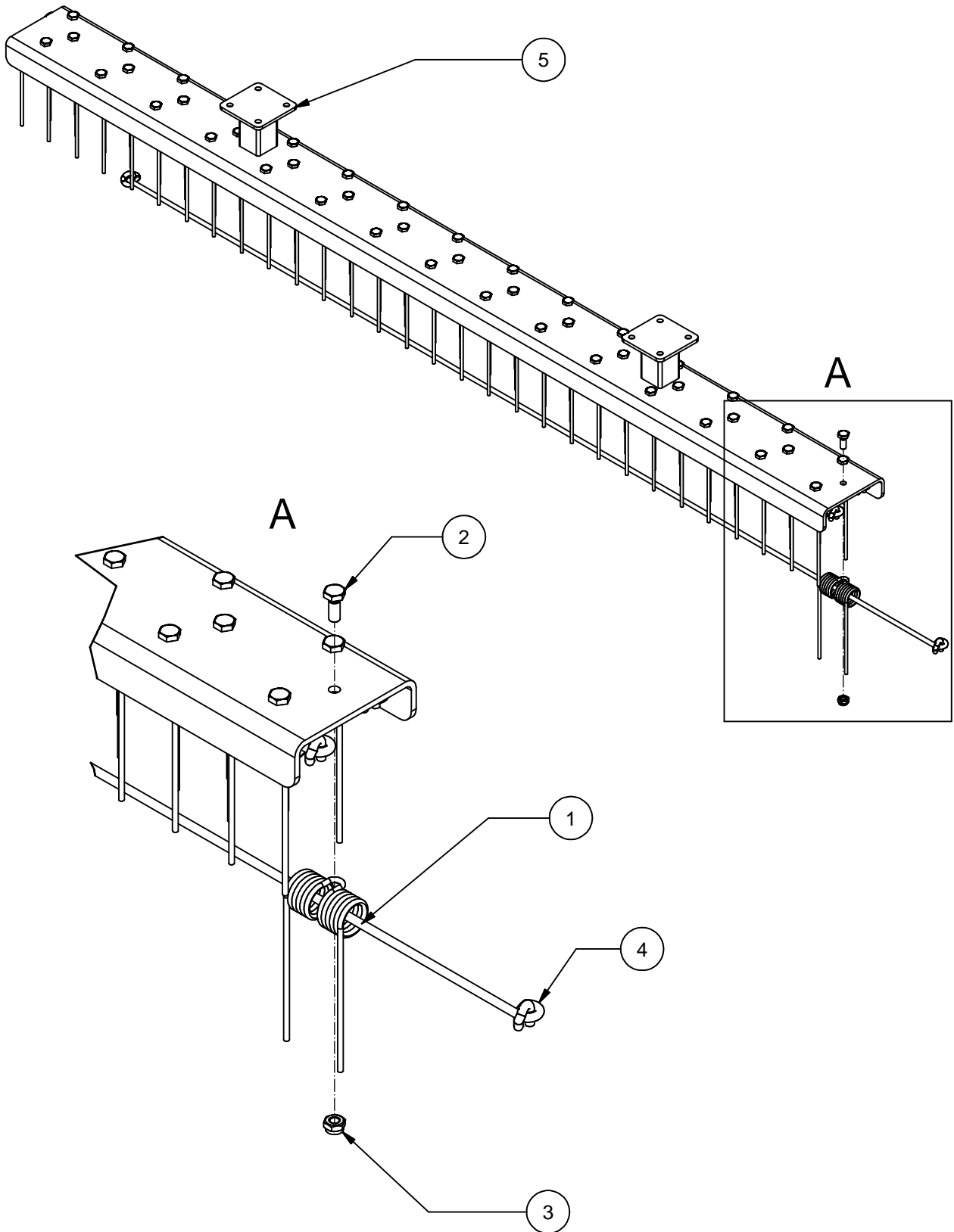

	PART #	DESCRIPTION	REMARKS	QUA
1	361.105.170	Spring Tine Heavy Duty		45
2	804.100.250	Bolt DIN 933 - M10 x 25		45
3	830.100.100	SL Nut DIN 985 - M10		45
4	899.080.200	Rope		3
5	494.202.015	Heavy Duty Rake Beam VG		1